

FEATURES

- **SO Package with Standard Pinout**
- **Supply Current per Amplifier: 17 μ A Max**
- **Offset Voltage: 70 μ V Max**
- Offset Current: 250pA Max
- Input Bias Current: 5nA Max
- Voltage Noise: 0.9 μ V_{p-p}, 0.1Hz to 10Hz
- Current Noise: 1.5pA_{p-p}, 0.1Hz to 10Hz
- Offset Voltage Drift: 0.5 μ V/ $^{\circ}$ C
- Gain Bandwidth Product: 85kHz
- Slew Rate: 0.04V/ μ s
- Single Supply Operation
 - Input Voltage Range Includes Ground
 - Output Swings to Ground while Sinking Current
 - No Pull-Down Resistors Needed
- Output Sources and Sinks 5mA Load Current

APPLICATIONS

- Battery- or Solar-Powered Systems
 - Portable Instrumentation
 - Remote Sensor Amplifier
 - Satellite Circuitry
- Micropower Sample-and-Hold
- Thermocouple Amplifier
- Micropower Filters

LT, LTC and LT are registered trademarks of Linear Technology Corporation.

DESCRIPTION

The LT[®]2178 is a micropower dual op amp in a surface mount standard 8-pin configuration, the LT2179 is a micropower quad op amp offered in a surface mount 14-pin package. Both devices are optimized for single supply operation at 5V. Specifications are also provided at ± 15 V supply.

The extremely low supply current is combined with true precision specifications: offset voltage is 30 μ V and offset current is 50pA. Both offset parameters have low drift with temperature. The 1.5pA_{p-p} current noise and picoampere offset current permit the use the megohm level source resistors without introducing serious errors. Voltage noise, at 0.9 μ V_{p-p}, is remarkably low considering the low supply current.

The LT2178/LT2179 can be operated from a single supply (as low as one lithium-cell or two NiCd batteries). The input range goes below ground. The all-NPN output stage swings to within a few millivolts of ground while sinking current. No power consuming pull down resistors are needed.

For surface mount applications where three times higher supply current is acceptable, the micropower LT1077 single, LT2078 dual and LT2079 quad are recommended. The LT1077/LT2078/LT2079 have significantly higher bandwidth, slew rate, lower voltage noise and better output drive capability. For applications requiring DIP packages refer to the LT1178/LT1179.

TYPICAL APPLICATION

Self-Buffered, Dual Output, Micropower Reference

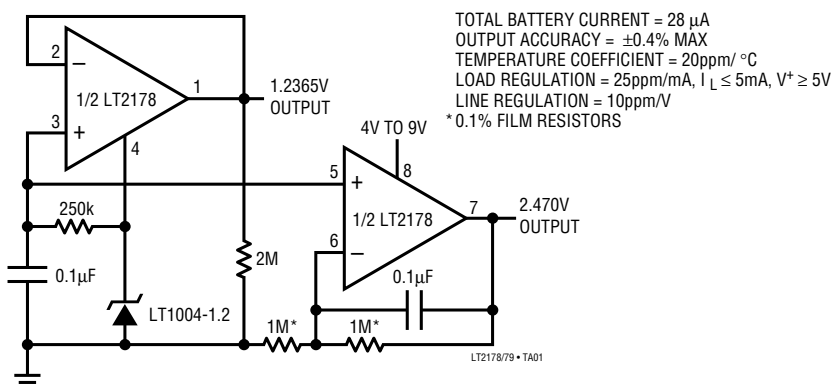

Supply Current vs Temperature

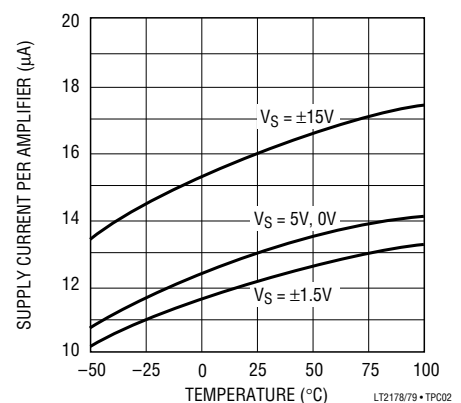

LT2178/LT2179

ABSOLUTE MAXIMUM RATINGS

Supply Voltage $\pm 22\text{V}$
 Differential Input Voltage $\pm 30\text{V}$
 Input Voltage Equal to Positive Supply Voltage
 5V Below Negative Supply Voltage
 Output Short-Circuit Duration Indefinite

Specified Temperature Range
 Commercial 0°C to 70°C
 Industrial -40°C to 85°C
 Storage Temperature Range -65°C to 150°C
 Lead Temperature (Soldering, 10 sec) 300°C

PACKAGE/ORDER INFORMATION

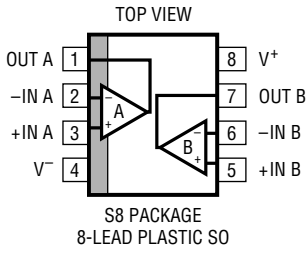
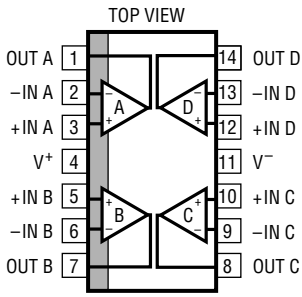
 <p>S8 PACKAGE 8-LEAD PLASTIC SO</p> <p>$T_{JMAX} = 150^{\circ}\text{C}$, $\theta_{JA} = 190^{\circ}\text{C/W}$</p>	ORDER PART NUMBER	 <p>S PACKAGE 14-LEAD PLASTIC SO</p> <p>$T_{JMAX} = 150^{\circ}\text{C}$, $\theta_{JA} = 150^{\circ}\text{C/W}$</p>	ORDER PART NUMBER
	LT2178ACS8 LT2178AIS8 LT2178CS8 LT2178IS8		LT2179ACS LT2179AIS LT2179CS LT2179IS
	PART MARKING		
	2178A 2178 2178AI 2178I		

Consult factory for Military grade parts.

ELECTRICAL CHARACTERISTICS

$V_S = 5\text{V}$, 0V , $V_{CM} = 0.1\text{V}$, $V_O = 1.4\text{V}$, $T_A = 25^{\circ}\text{C}$, unless otherwise noted.

SYMBOL	PARAMETER	CONDITIONS (NOTE 1)	LT2178AC/LT2178AI LT2179AC/LT2179AI			LT2178C/LT2178I LT2179C/LT2179I			UNITS
			MIN	TYP	MAX	MIN	TYP	MAX	
V_{OS}	Input Offset Voltage	LT2178 LT2179		30 35	70 100	40 40	120 150	μV μV	
$\frac{\Delta V_{OS}}{\Delta \text{Time}}$	Long Term Input Offset Voltage Stability			0.5		0.6		$\mu\text{V/Mo}$	
I_{OS}	Input Offset Current			0.05	0.25	0.05	0.35	nA	
I_B	Input Bias Current			3	5	3	6	nA	
e_n	Input Noise Voltage	0.1Hz to 10Hz (Note 2)		0.9	2.0	0.9		μV_{p-p}	
	Input Noise Voltage Density	$f_0 = 10\text{Hz}$ (Note 2) $f_0 = 1000\text{Hz}$ (Note 2)		50 49	75 65	50 49		$\text{nV}/\sqrt{\text{Hz}}$ $\text{nV}/\sqrt{\text{Hz}}$	
i_n	Input Noise Current	0.1Hz to 10Hz (Note 2)		1.5	2.5	1.5		pA_{p-p}	
	Input Noise Current Density	$f_0 = 10\text{Hz}$ (Note 2) $f_0 = 1000\text{Hz}$		0.03 0.01	0.07	0.03 0.01		$\text{pA}/\sqrt{\text{Hz}}$ $\text{pA}/\sqrt{\text{Hz}}$	
	Input Resistance Differential Mode Common Mode	(Note 3)	0.8	2.0 12		0.6	2.0 12	$\text{G}\Omega$ $\text{G}\Omega$	
	Input Voltage Range		3.5 0	3.9 -0.3		3.5 0	3.9 -0.3	V V	
CMRR	Common Mode Rejection Ratio	$V_{CM} = 0\text{V}$ to 3.5V	93	103		90	102	dB	
PSRR	Power Supply Rejection Ratio	$V_S = 2.2\text{V}$ to 12V	94	104		92	104	dB	

ELECTRICAL CHARACTERISTICS $V_S = 5V, 0V, V_{CM} = 0.1V, V_O = 1.4V, T_A = 25^\circ C$, unless otherwise noted.

SYMBOL	PARAMETER	CONDITIONS (NOTE 1)	LT2178AC/LT2178AI LT2179AC/LT2179AI			LT2178C/LT2178I LT2179C/LT2179I			UNITS
			MIN	TYP	MAX	MIN	TYP	MAX	
A_{VOL}	Large-Signal Voltage Gain	$V_O = 0.03V$ to $4V$, No Load (Note 3) $V_O = 0.03V$ to $3.5V, R_L = 50k$	140 80	700 200		110 70	700 200		V/mV V/mV
	Maximum Output Voltage Swing	Output Low, No Load		6.5	9		6.5	9	mV
		Output Low, $2k$ to GND Output Low, $I_{SINK} = 100\mu A$		0.2 120	0.6 160		0.2 120	0.6 160	mV mV
		Output High, No Load Output High, $2k$ to GND	4.2 3.5	4.4 3.8		4.2 3.5	4.4 3.8		V V
SR	Slew Rate	$A_V = 1, C_L = 10pF$ (Note 3)	0.013	0.025		0.013	0.025		V/ μs
GBW	Gain Bandwidth Product	$f_0 \leq 5kHz$		60			60		kHz
I_S	Supply Current per Amplifier	$V_S = \pm 1.5V, V_O = 0V$		13 12	18 17		14 13	21 20	μA μA
	Channel Separation	$\Delta V_{IN} = 3V, R_L = 10k$		110			110		dB
	Minimum Supply Voltage	(Note 4)		2.0	2.2		2.0	2.2	V

$V_S = 5V, 0V, V_{CM} = 0.1V, V_O = 1.4V, -40^\circ C \leq T_A \leq 85^\circ C$ for I grades, unless otherwise noted. (Note 6)

SYMBOL	PARAMETER	CONDITIONS		LT2178AI/LT2179AI			LT2178I/LT2179I			UNITS
				MIN	TYP	MAX	MIN	TYP	MAX	
V_{OS}	Input Offset Voltage	LT2178 LT2179	● ●	70 80	270 300		95 100	370 400	μV μV	
$\frac{\Delta V_{OS}}{\Delta T}$	Input Offset Voltage Drift	LT2178 (Note 5) LT2179	●	0.4 0.5	1.8 3.0		0.5 0.6	2.5 3.5	$\mu V/^\circ C$ $\mu V/^\circ C$	
I_{OS}	Input Offset Current		●	0.07	0.70		0.1	1.0	nA	
I_B	Input Bias Current		●	3	7		4	8	nA	
CMRR	Common Mode Rejection Ratio	$V_{CM} = 0.05V$ to $3.2V$	●	86	100		84	98	dB	
PSRR	Power Supply Rejection Ratio	$V_S = 3V$ to $12V$	●	88	100		86	100	dB	
A_{VOL}	Large-Signal Voltage Gain	$V_O = 0.05V$ to $4V$, No Load (Note 3) $V_O = 0.05V$ to $3.5V, R_L = 50k$	● ●	75 40	350 130		50 30	350 130	V/mV V/mV	
	Maximum Output Voltage Swing	Output Low, No Load Output Low, $I_{SINK} = 100\mu A$	● ●		9 160	13 220		9 160	13 220	mV mV
		Output High, No Load Output High, $2k$ to GND	● ●	3.9 3.0	4.2 3.7		3.9 3.0	4.2 3.7		V V
I_S	Supply Current per Amplifier		●	15	24		15	27	μA	

$V_S = 5V, 0V, V_{CM} = 0.1V, V_O = 1.4V, 0^\circ C \leq T_A \leq 70^\circ C$, unless otherwise noted. (Note 7)

SYMBOL	PARAMETER	CONDITIONS		LT2178AC/LT2179AC			LT2178C/LT2179C			UNITS
				MIN	TYP	MAX	MIN	TYP	MAX	
V_{OS}	Input Offset Voltage	LT2178 LT2179	● ●	50 60	170 200		65 70	250 290	μV μV	
$\frac{\Delta V_{OS}}{\Delta T}$	Input Offset Voltage Drift	LT2178 (Note 5) LT2179	●	0.4 0.5	1.8 3.0		0.5 0.6	2.5 3.5	$\mu V/^\circ C$ $\mu V/^\circ C$	
I_{OS}	Input Offset Current		●	0.06	0.35		0.06	0.50	nA	
I_B	Input Bias Current		●	3	6		3	7	nA	
CMRR	Common Mode Rejection Ratio	$V_{CM} = 0V$ to $3.4V$	●	90	101		86	100	dB	
PSRR	Power Supply Rejection Ratio	$V_S = 2.5V$ to $12V$	●	90	102		88	102	dB	

ELECTRICAL CHARACTERISTICS $V_S = 5V, 0V, V_{CM} = 0.1V, V_O = 1.4V, 0^\circ C \leq T_A \leq 70^\circ C$, unless otherwise noted.

SYMBOL	PARAMETER	CONDITIONS		LT2178AC/LT2179AC			LT2178C/LT2179C			UNITS
				MIN	TYP	MAX	MIN	TYP	MAX	
A_{VOL}	Large-Signal Voltage Gain	$V_O = 0.05V$ to $4V$, No Load (Note 3) $V_O = 0.05V$ to $3.5V$, $R_L = 50k$	●	150	500		80	500		V/mV
			●	55	160		45	160		V/mV
	Maximum Output Voltage Swing	Output Low, No Load Output Low, $I_{SINK} = 100\mu A$	●		8	11		8	11	mV
			●		140	190		140	190	mV
		Output High, No Load Output High, $2k$ to GND	●	4.1	4.3		4.1	4.3		V
			●	3.3	3.8		3.3	3.8		V
I_S	Supply Current per Amplifier		●		14	21		15	24	μA

$V_S = \pm 15V, T_A = 25^\circ C$, unless otherwise noted.

SYMBOL	PARAMETER	CONDITIONS		LT2178AC/LT2178AI LT2179AC/LT2179AI			LT2178C/LT2178I LT2179C/LT2179I			UNITS
				MIN	TYP	MAX	MIN	TYP	MAX	
V_{OS}	Input Offset Voltage	LT2178 LT2179			70	300		90	400	μV
					80	350		100	450	μV
I_{OS}	Input Offset Current			0.05	0.25		0.05	0.35	nA	
I_B	Input Bias Current			3	5		3	6	nA	
	Input Voltage Range			13.5 -15.0	13.9 -15.3		13.5 -15.0	13.9 -15.3	V V	
CMRR	Common Mode Rejection Ratio	$V_{CM} = 13.5V$ to $-15V$		96	106		93	106	dB	
PSRR	Power Supply Rejection Ratio	$V_S = 5V, 0V$ to $\pm 18V$		96	112		94	112	dB	
A_{VOL}	Large-Signal Voltage Gain	$V_O = \pm 10V, R_L = 50k$ $V_O = \pm 10V$, No Load		300	1200		250	1000		V/mV
				600	2500		400	2500		V/mV
V_{OUT}	Maximum Output Voltage Swing	$R_L = 50k$ $R_L = 2k$		± 13.0	± 14.2		± 13.0	± 14.2		V
				± 11.0	± 12.7		± 11.0	± 12.7		V
SR	Slew Rate	$A_V = 1$		0.02	0.04		0.02	0.04	V/ μs	
GBW	Gain Bandwidth Product	$f_0 \leq 5kHz$			85			85	kHz	
I_S	Supply Current per Amplifier			16	21		17	25	μA	

$V_S = \pm 15V, -40^\circ C \leq T_A \leq 85^\circ C$ for I grades, unless otherwise noted.

SYMBOL	PARAMETER	CONDITIONS		LT2178AI/LT2179AI			LT2178I/LT2179I			UNITS
				MIN	TYP	MAX	MIN	TYP	MAX	
V_{OS}	Input Offset Voltage	LT2178 LT2179	●		100	650		130	740	μV
			●		100	650		130	740	μV
$\frac{\Delta V_{OS}}{\Delta T}$	Input Offset Voltage Drift	LT2178 (Note 5) LT2179	●		0.6	1.8		0.7	2.5	$\mu V/^\circ C$
					0.7	3.0		0.9	4.0	$\mu V/^\circ C$
I_{OS}	Input Offset Current		●		0.07	0.70		0.1	1.0	nA
I_B	Input Bias Current		●		3	7		4	8	nA
A_{VOL}	Large-Signal Voltage Gain	$V_O = \pm 10V, R_L = 50k$	●	150	500		100	500		V/mV
CMRR	Common Mode Rejection Ratio	$V_{CM} = 13V, -14.9V$	●	90	105		88	103		dB
PSRR	Power Supply Rejection Ratio	$V_S = 0V, 5V$ to $\pm 18V$	●	92	110		88	109		dB
	Maximum Output Voltage Swing	$R_L = 5k$	●	± 11.0	± 13.5		± 11.0	± 13.5		V
I_S	Supply Current per Amplifier		●		18	28		19	30	μA

ELECTRICAL CHARACTERISTICS

$V_S = \pm 15V, 0^\circ C \leq T_A \leq 70^\circ C$, unless otherwise noted.

SYMBOL	PARAMETER	CONDITIONS	LT2178AC/LT2179AC			LT2178C/LT2179C			UNITS
			MIN	TYP	MAX	MIN	TYP	MAX	
V_{OS}	Input Offset Voltage	LT2178 LT2179	● ●	100 120	480 550	130 150	660 750	μV μV	
$\frac{\Delta V_{OS}}{\Delta T}$	Input Offset Voltage Drift	LT2178 (Note 5) LT2179	●	0.6 0.7	1.8 3.0	0.7 0.9	2.5 4.0	$\mu V/^\circ C$ $\mu V/^\circ C$	
I_{OS}	Input Offset Current		●	0.06	0.35	0.06	0.35	nA	
I_B	Input Bias Current		●	3	6	3	7	nA	
A_{VOL}	Large-Signal Voltage Gain	$V_O = \pm 10V, R_L = 50k$	●	200	800	150	750	V/mV	
CMRR	Common Mode Rejection Ratio	$V_{CM} = 13V, -15V$	●	94	104	91	104	dB	
PSRR	Power Supply Rejection Ratio	$V_S = 5V, 0V$ to $\pm 18V$	●	93	110	91	110	dB	
	Maximum Output Voltage Swing	$R_L = 5k$	●	± 11.0	± 13.6	± 11.0	± 13.6	V	
I_S	Supply Current per Amplifier		●	17	24	18	28	μA	

The ● denotes specifications which apply over the full operating temperature range.

Note 1: Typical parameters are defined as the 60% yield of parameter distributions of individual amplifiers, i.e., out of 100 LT2179s (or 100 LT2178s) typically 240 op amps (or 120) will be better than the indicated specification.

Note 2: This parameter is tested on a sample basis only. All noise parameters are tested with $V_S = \pm 2.5V, V_O = 0V$.

Note 3: This parameter is guaranteed by design and is not tested.

Note 4: Power supply rejection ratio is measured at the minimum supply voltage. The op amps actually work at 1.7V supply but with a typical offset skew of $-300\mu V$.

Note 5: This parameter is not 100% tested.

Note 6: During testing at $-40^\circ C$, the 5V power supply turn-on time is less than 0.5s.

Note 7: The LT2178C/LT2179C are designed, characterized and expected to meet the industrial temperature limits, but are not tested at $-40^\circ C$ and $85^\circ C$. I-grade parts are guaranteed.

TYPICAL PERFORMANCE CHARACTERISTICS

Distribution of Input Offset Voltage

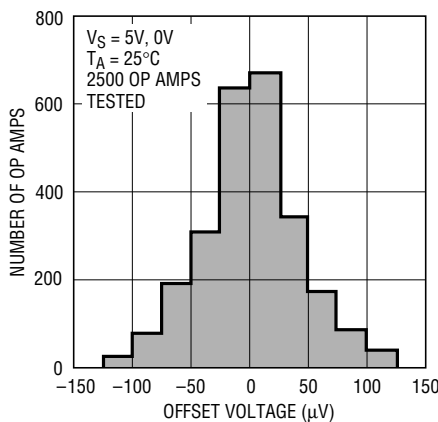

LT2178/79 • TPC01

Minimum Supply Voltage

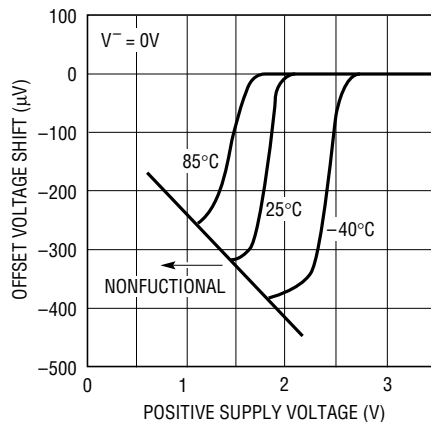

LT2178/79 • TPC02

Input Bias and Offset Currents vs Temperature

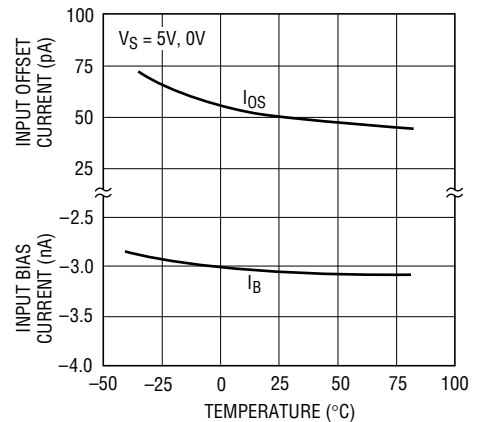

LT2178/79 • TPC03

TYPICAL PERFORMANCE CHARACTERISTICS

Output Saturation vs Temperature vs Sink Current

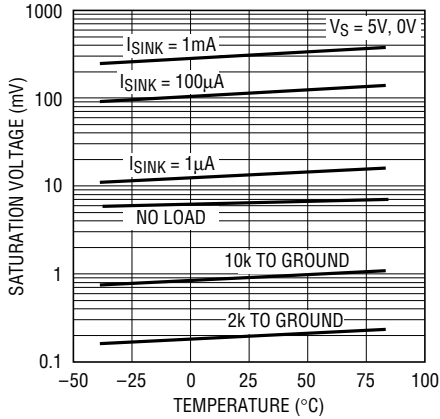

LT2178/79 • TPC04

Short-Circuit Current

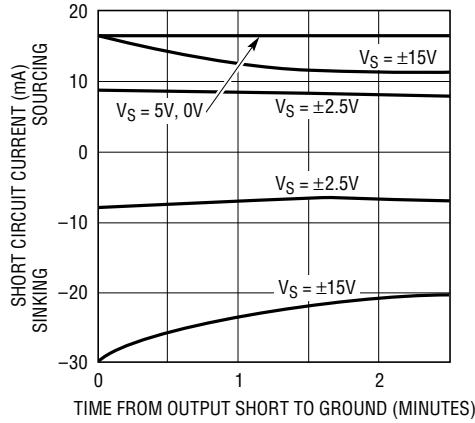

LT2178/79 • TPC05

0.1Hz to 10Hz Noise

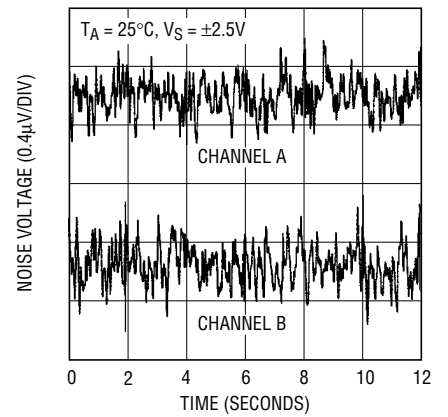

LT2178/79 • TPC06

0.01Hz to 10Hz Noise

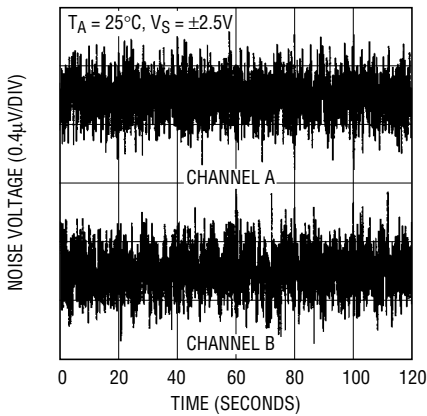

LT2178/79 • TPC07

Noise Spectrum

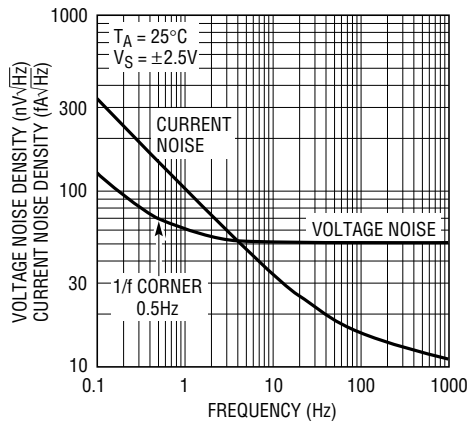

LT2178/79 • TPC08

Voltage Gain vs Frequency

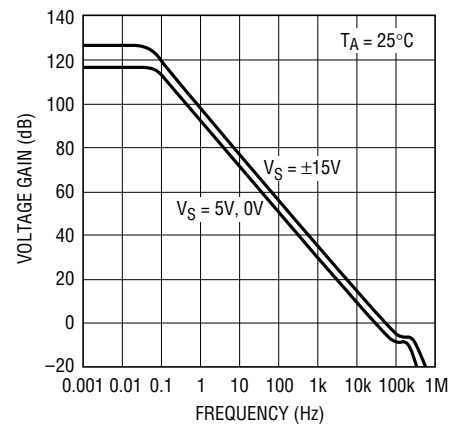

LT2178/79 • TPC09

Gain, Phase vs Frequency

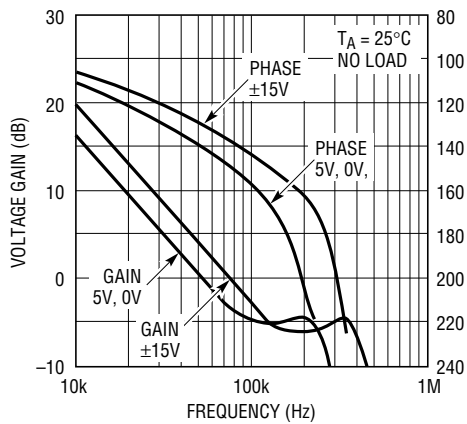

LT2178/79 • TPC10

Voltage Gain vs Load Resistance

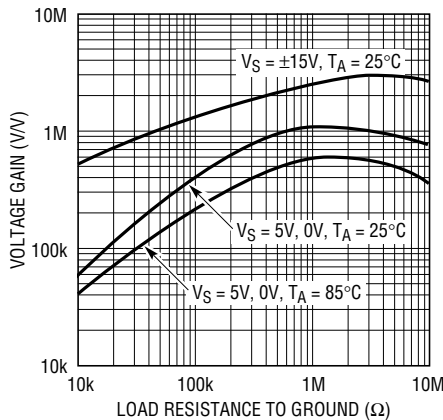

LT2178/79 • TPC11

Capacitive Load Handling

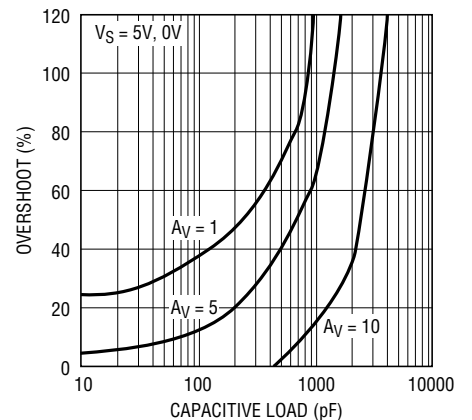

LT2078/79 • TPC12

TYPICAL PERFORMANCE CHARACTERISTICS

Large-Signal Transient Response
 $V_S = \pm 15V$

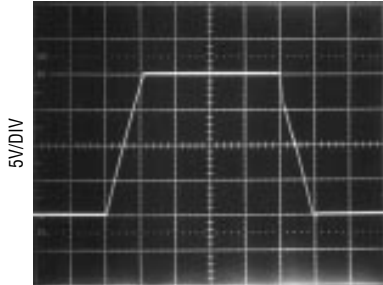

$A_V = 1$ 500µs/DIV
 $C_L = 12pF$ LT2178/79 • TPC13

Large-Signal Transient Response
 $V_S = 5V, 0V$



$A_V = 1$ 100µs/DIV
 $C_L = 12pF$
 INPUT PULSE = 0V TO 3.8V LT2178/79 • TPC14

Small-Signal Transient Response
 $V_S = \pm 2.5V$

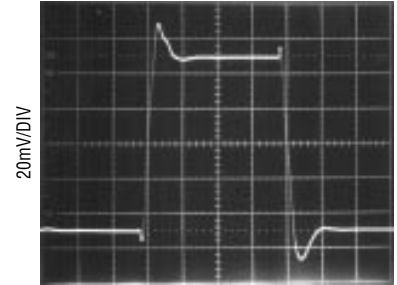

$A_V = 1$ 20µs/DIV
 $C_L = 12pF$ LT2178/79 • TPC15

Small-Signal Transient Response
 $V_S = \pm 15V$

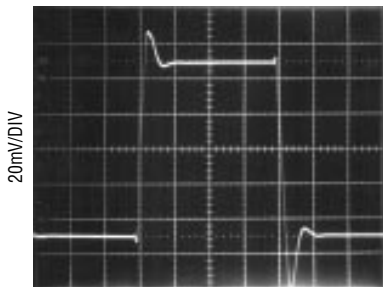

$A_V = 1$ 20µs/DIV
 $C_L = 12pF$ LT2178/79 • TPC16

Small-Signal Transient Response
 $V_S = 5V, 0V$

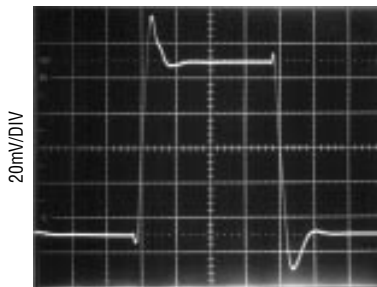

$A_V = 1$ 20µs/DIV
 $C_L = 12pF$
 INPUT PULSE = 50mV TO 150mV LT2178/79 • TPC17

Common Mode Rejection Ratio vs Frequency

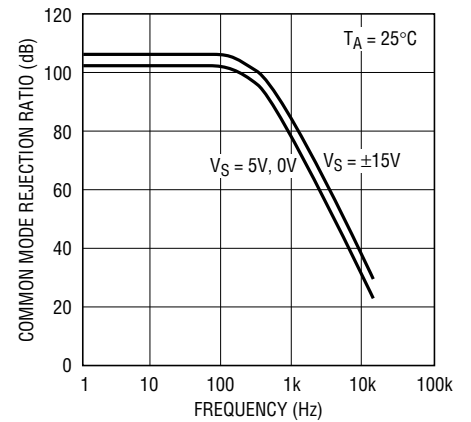

LT2178/79 • TPC18

Power Supply Rejection Ratio vs Frequency

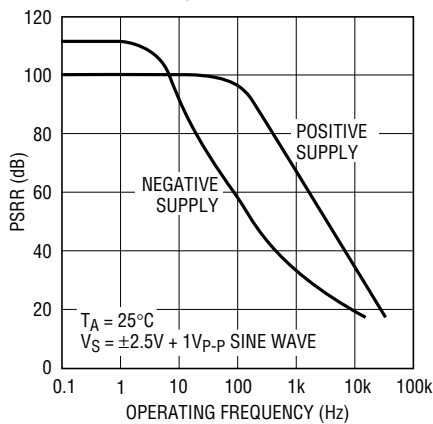

LT2178/79 • TPC19

Closed Loop Output Impedance

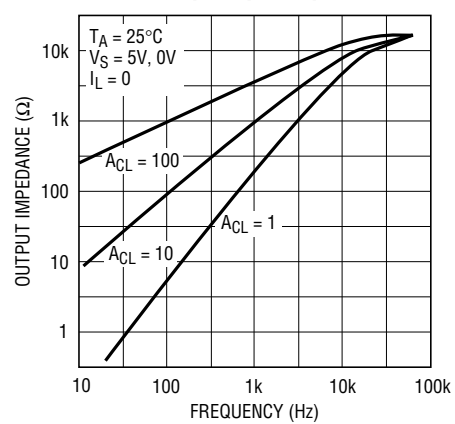

LT2178/79 • TPC20

SIMPLIFIED SCHEMATIC

1/2 LT2178
1/4 LT2179

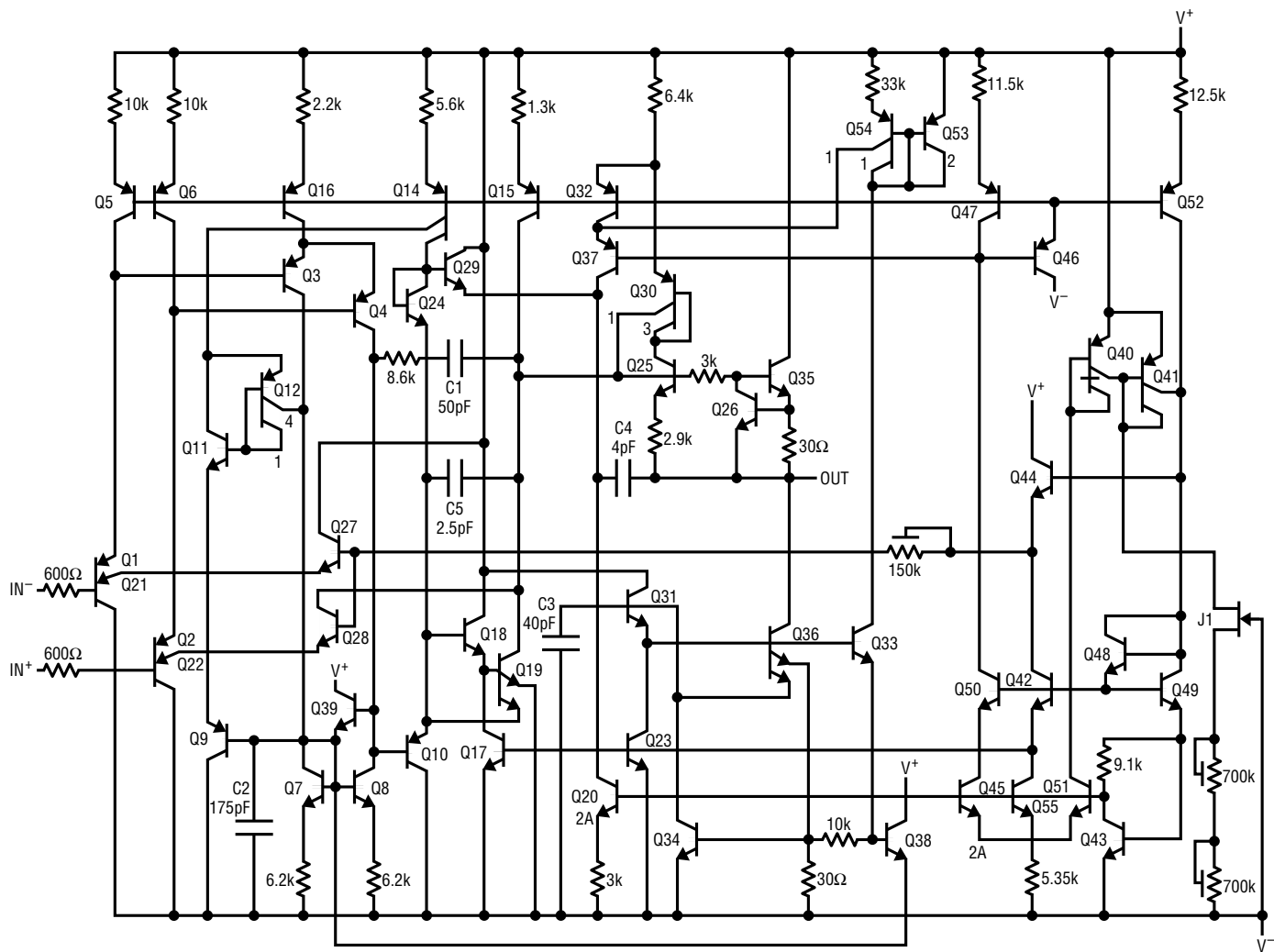

LT2178/79 • SIMPLIFIED SCHEM

APPLICATIONS INFORMATION

Please see the LT2078/LT2079 data sheet for applications information. All comments relating to specifications, single

supply operation and phase reversal protection are directly applicable to the LT2178/LT2179.

Micropower 100Hz to 1MHz V-to-F Converter

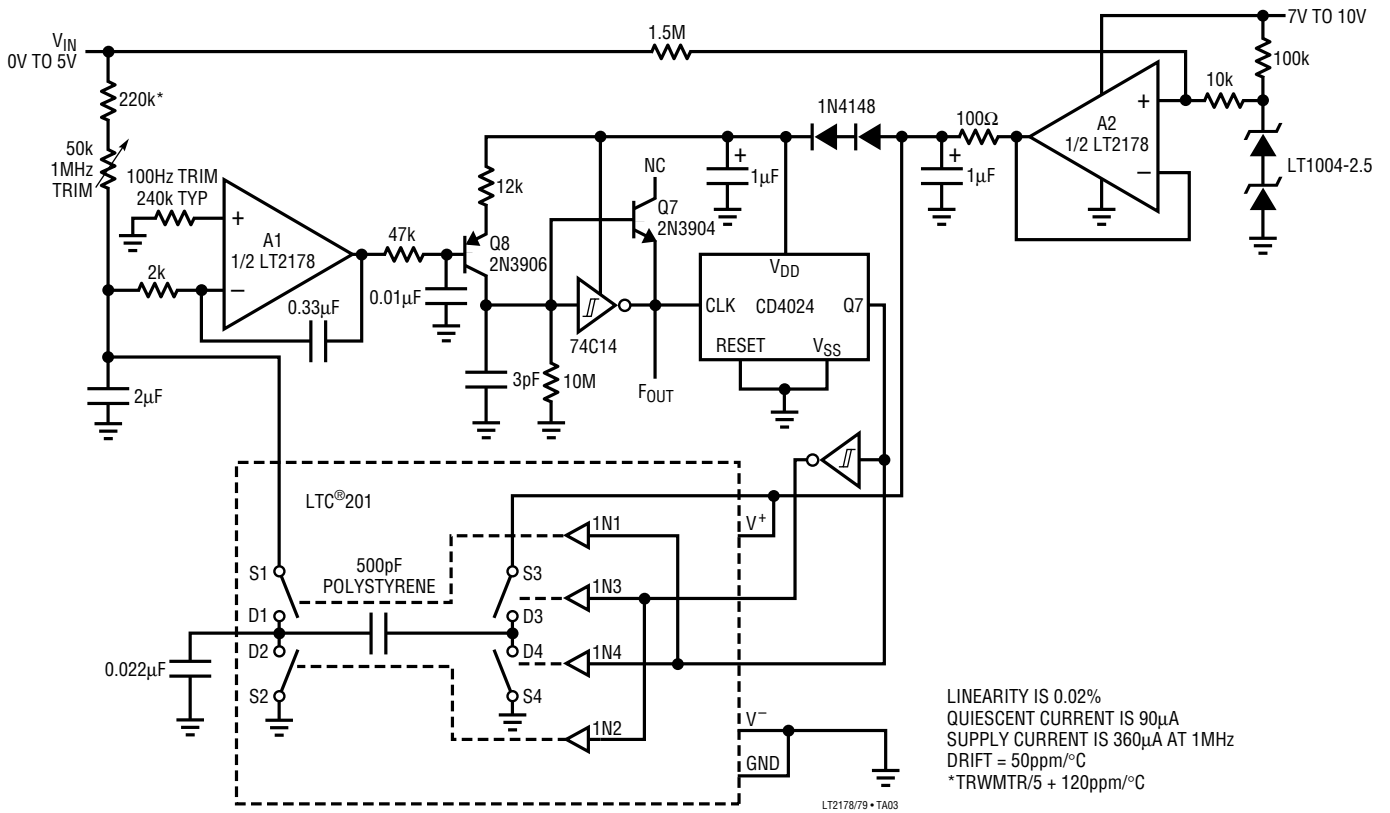

PACKAGE DESCRIPTION Dimensions in inches (millimeters) unless otherwise noted.

S8 Package
8-Lead Plastic Small Outline (Narrow 0.150)
 (LTC DWG # 05-08-1610)

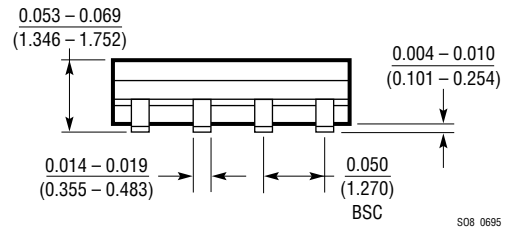
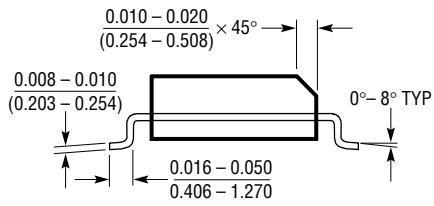
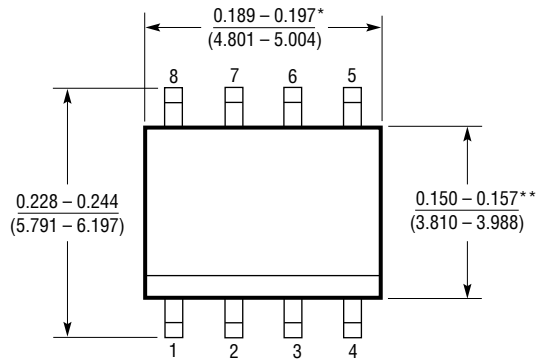

*DIMENSION DOES NOT INCLUDE MOLD FLASH. MOLD FLASH SHALL NOT EXCEED 0.006" (0.152mm) PER SIDE
 **DIMENSION DOES NOT INCLUDE INTERLEAD FLASH. INTERLEAD FLASH SHALL NOT EXCEED 0.010" (0.254mm) PER SIDE

S08 0695

PACKAGE DESCRIPTION Dimensions in inches (millimeters) unless otherwise noted.

S Package
14-Lead Plastic Small Outline (Narrow 0.150)
 (LTC DWG # 05-08-1610)

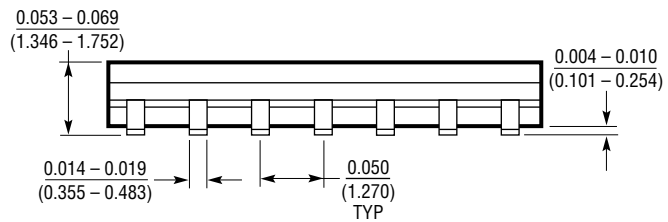
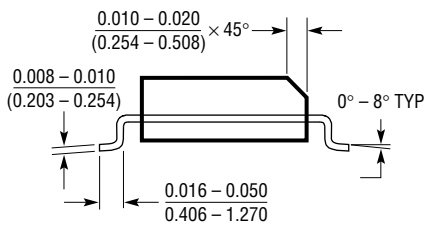
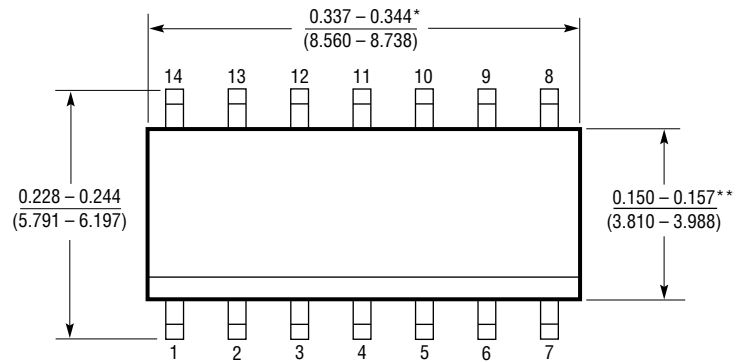

* DIMENSION DOES NOT INCLUDE MOLD FLASH. MOLD FLASH SHALL NOT EXCEED 0.006" (0.152mm) PER SIDE
 ** DIMENSION DOES NOT INCLUDE INTERLEAD FLASH. INTERLEAD FLASH SHALL NOT EXCEED 0.010" (0.254mm) PER SIDE

S14 0695

TYPICAL APPLICATION

Single Supply, 1kHz, 4th Order Butterworth Lowpass Filter

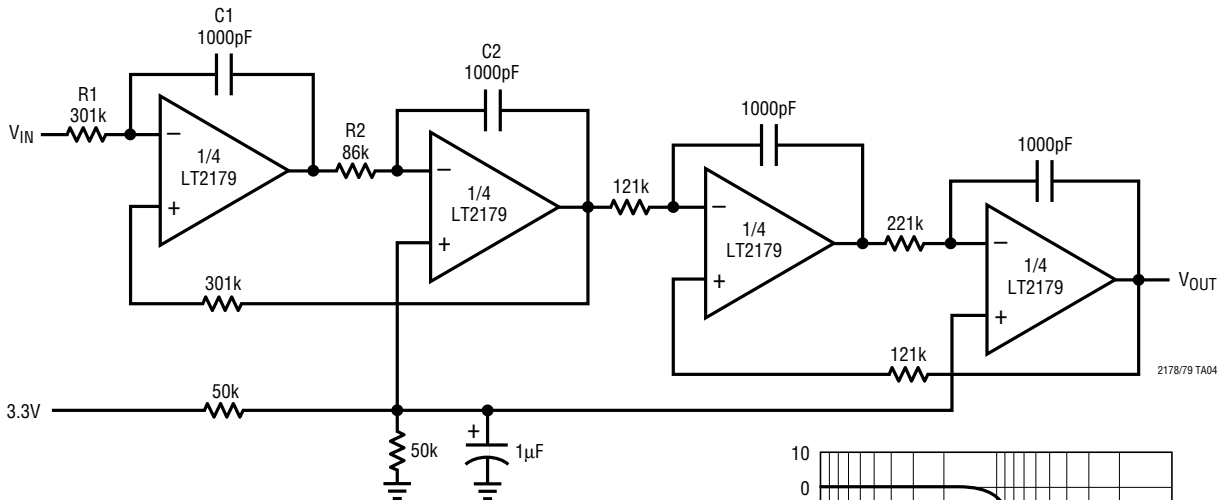

12-BIT ACCURATE SIGNAL RANGE FROM 6mV TO 1.8V ON 3.3V SINGLE SUPPLY.
MAXIMUM OUTPUT OFFSET ERROR IS 448μV.

FOR EACH 2ND ORDER SECTION:

$$W_0^2 = \frac{1}{C1C2R1R2}$$

$$R1 = \frac{1}{W_0QC1}$$

$$R2 = \frac{Q}{W_0C2}$$

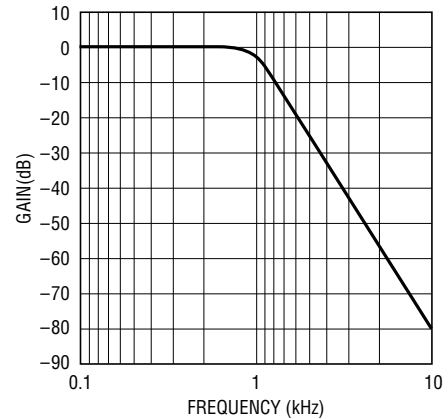

LT2178/79 • TA05

RELATED PARTS

PART NUMBER	DESCRIPTION	COMMENTS
LT1078/LT1079	Dual/Quad 55μA Max, Single Supply Precision Op Amps	70μV V _{OS} Max and 2.5μV/°C Drift Max, 200kHz BBW, 0.07V/μs Slew Rate, Input/Output Common Mode Includes Ground
LT1211/LT1212	14MHz, 7V/μs Single Supply Dual and Quad Precision Op Amps	275μV V _{OS} Max, 6μV/°C Drift Max Input Voltage Range Includes Ground
LT1490/LT1491	Dual/ Quad Micropower Rail-to-Rail Input and Output Op Amps	Single Supply Input Range: -0.4V to 44V, Micropower 50μA Amplifier, Rail-to-Rail Input and Output, 200kHz GBW
LT2078/LT2079	Dual/Quad 55μA Max, Single Supply Precision Op Amps	70μV V _{OS} Max and 2.5μV/°C Drift Max, 200kHz BBW, 0.07V/μs Slew Rate, Input/Output Common Mode Includes Ground Surface Mount Standard Pinout